

ETU-LINK

Optical Communication System

SFP+ Series

SFP+

ES5561-3LCD40

6.25Gbps SFP+ Optical Transceiver, 40KM Reach

- Hot-pluggable SFP+ footprint
- Supports 6.25g to 11.3Gb/s bit rates
- Single 3.3V power supply
- Maximum link length of 40km
- 1550nm EML transmitter, PIN photo-detector
- Duplex LC connector
- Power dissipation < 1.5W
- Built-in digital diagnostic functions
- Case temperature range :
Standard:-5to +70°C
Industrial:-40 to +85°C



Applications

- 6.25G/8.5G/10GBASE-ER/EW
- 10G Ethernet

Standard

- Compliant with SFF-8472 SFP+ MSA.
- Compliant to SFP+ SFF-8431 and SFF-8432.
- RoHS Compliant.

Pin Definitions

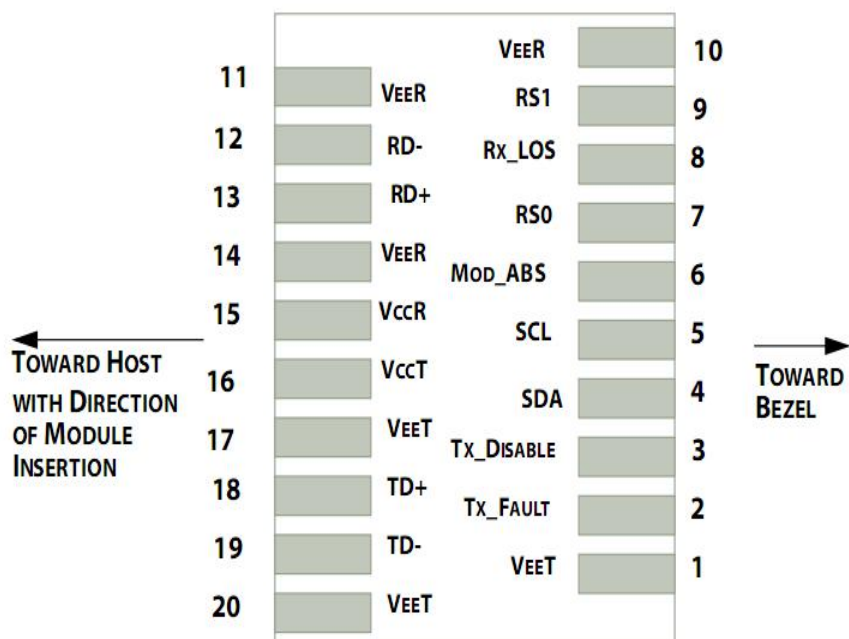

Pinout of Connector Block on Host Board

Absolute Maximum Ratings

Parameter	Symbol	Min.	Typ.	Max.	Unit	Note
Storage Temperature	Ts	-40		85	°C	
Storage Ambient Humidity	HA	5		85	%	
Power Supply Voltage	VCC	-0.5		4	V	
Signal Input Voltage		-0.3		Vcc+0.3	V	
Receiver Damage Threshold		+4			dBm	

Optical Characteristics

Parameter	Symbol	Min.	Typ.	Max.	Unit	Note
Transmitter						
Average Launched Power	PO	-1		3	dBm	Note (1)
Extinction Ratio	ER	6			dB	
Center Wavelength	λ_C	1530	1550	1565	nm	
Spectrum Band Width (RMS)	σ			1.0	nm	
SMSR		30			dB	
Transmitter OFF Output Power	POff			-40	dBm	
Optical Rise/Fall Time	tr/tf		100	260	ps	Note (2)
Transmitter and Dispersion Penalty	TDP			3.0	dB	
Output Eye Mask	Compliant with IEEE 0802.3ae					
Receiver						
Input Optical Wavelength	λ	1270		1610	nm	
Receiver Sensitivity				-16.4	dBm	Note (3)
Input Saturation Power (Overload)	Psat	0.5			dBm	
LOS Detect -Assert Power	PA			-19	dBm	
LOS Detect - Deassert Power	PD	-28			dBm	
LOS Detect Hysteresis	PHYS	0.5			dB	

Notes:

- 1) Launched power (avg.) is power coupled into a single mode fiber with master connector. (Before of Life)
- 2) These are unfiltered 20-80% values.
- 3) Measured with conformance test signal for BER = 10^{-12} .@6.25Gbps, PRBS=2³¹-1,NRZ

Pin Descriptions

Pin	Symbol	Name/Description	Ref.
1	V_{EET}	Transmitter Ground (Common with Receiver Ground)	1
2	T_{FAULT}	Transmitter Fault.	2
3	T_{DIS}	Transmitter Disable. Laser output disabled on high or open.	3
4	SDA	2-wire Serial Interface Data Line	4
5	SCL	2-wire Serial Interface Clock Line	4
6	MOD_ABS	Module Absent. Grounded within the module	4
7	RS0	Rate Select 0	5
8	LOS	Loss of Signal indication. Logic 0 indicates normal operation.	6
9	RS1	No connection required	1
10	V_{EER}	Receiver Ground (Common with Transmitter Ground)	1
11	V_{EER}	Receiver Ground (Common with Transmitter Ground)	1
12	RD-	Receiver Inverted DATA out. AC Coupled	
13	RD+	Receiver Non-inverted DATA out. AC Coupled	
14	V_{EER}	Receiver Ground (Common with Transmitter Ground)	1
15	V_{CCR}	Receiver Power Supply	
16	V_{CCT}	Transmitter Power Supply	
17	V_{EET}	Transmitter Ground (Common with Receiver Ground)	1
18	TD+	Transmitter Non-Inverted DATA in. AC Coupled.	
19	TD-	Transmitter Inverted DATA in. AC Coupled.	
20	V_{EET}	Transmitter Ground (Common with Receiver Ground)	1

Notes:

- 1) Circuit ground is internally isolated from chassis ground.
- 2) T_{FAULT} is an open collector/drain output, which should be pulled up with a 4.7k – 10k Ohms resistor on the host board if intended for use. Pull up voltage should be between 2.0V to $V_{cc} + 0.3V$. A high output indicates a transmitter fault caused by either the TX bias current or the TX output power exceeding the preset alarm thresholds. A low output indicates normal operation. In the low state, the output is pulled to <0.8V.
- 3) Laser output disabled on $T_{DIS} > 2.0V$ or open, enabled on $T_{DIS} < 0.8V$.
- 4) Should be pulled up with 4.7kΩ- 10kΩ host board to a voltage between 2.0V and 3.6V. MOD_ABS pulls line low to indicate module is plugged in.
- 5) Internally pulled down per SFF-8431 Rev 4.1.
- 6) LOS is open collector output. It should be pulled up with 4.7kΩ – 10kΩ on host board to a voltage between 2.0V and 3.6V. Logic 0 indicates normal operation; logic 1 indicates loss of signal.

Typical Interface Circuit

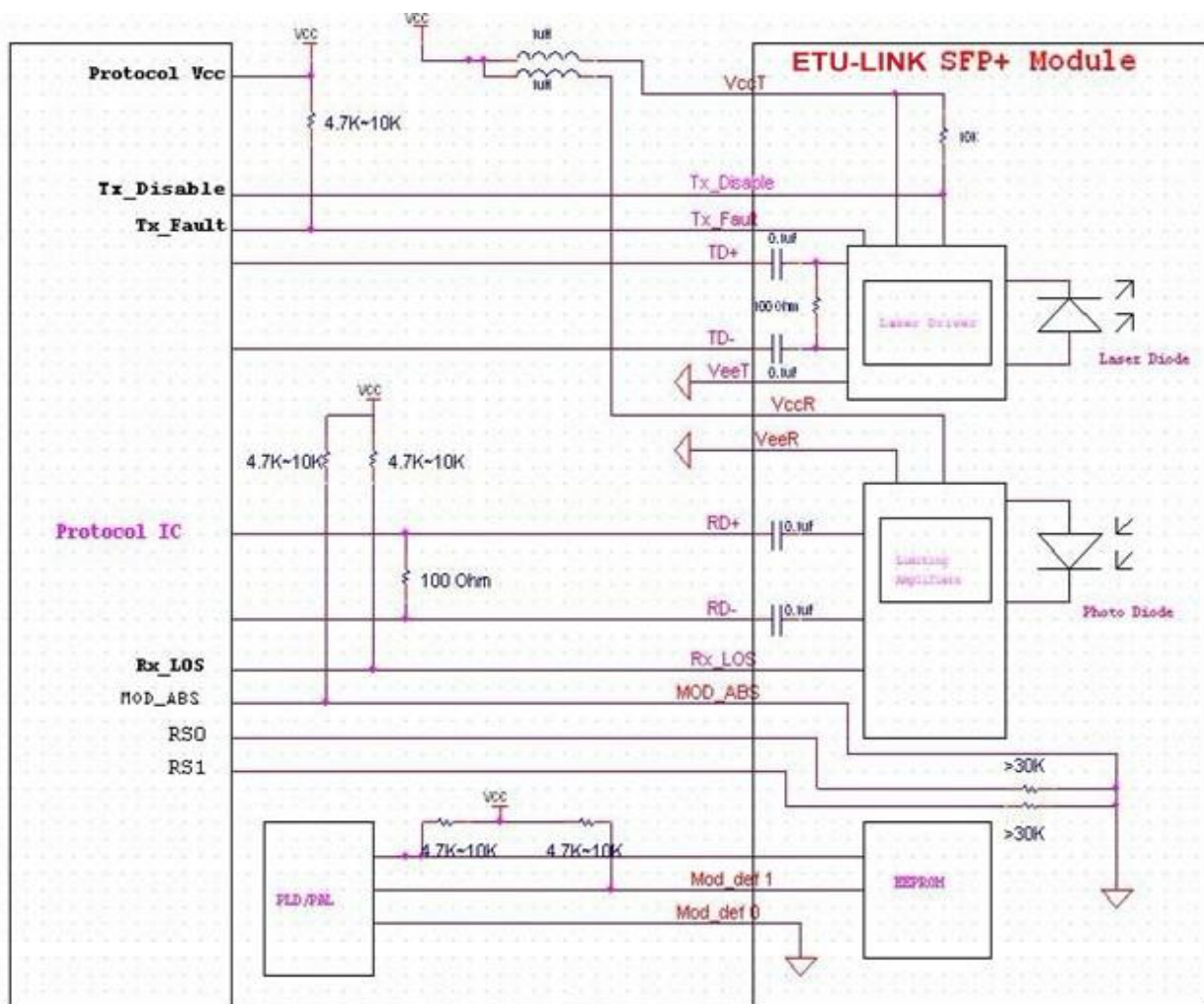

Electrical Interface Characteristics

Parameter	Symbol	Min.	Typ.	Max.	Unit	Note
Transmitter						
Differential line input Impedance	RIN		100		Ohm	
Differential Data Input Swing	VDT	300		700	mVp-p	
Transmit Disable Voltage	Vdis	2		Vcc	V	LVTTTL
Transmit Enable Voltage	Ven	Vee		Vee+0.8	V	
Receiver						

Differential Data Output Swing	VDR	400		850	mVp-p	Note (1)
LOS Output Voltage-High	VLOSH	Vee		Vee+0.8	V	LVTTL
LOS Output Voltage-Low	VLOSL	2		VccHOS T	V	

Notes:

1. Into 100Ω differential termination.

Digital Diagnostic Functions

ETU-LINK ES5561-3LCD40

transceivers support the 2-wire serial communication protocol as defined in the SFP+ MSA1. It is very closely related to the EEPROM defined in the GBIC standard, with the same electrical specifications.

The standard SFP+ serial ID provides access to identification information that describes the transceiver's capabilities, standard interfaces, manufacturer, and other information. Additionally, ETU-LINK SFP+ transceivers provide a unique enhanced digital diagnostic monitoring interface, which allows real-time access to device operating parameters such as transceiver temperature, laser bias current, transmitted optical power, and received optical power and transceiver supply voltage. It also defines a sophisticated system of alarm and warning flags, which alerts end-users when particular operating parameters are outside of a factory set normal range.

The SFP+ MSA defines a 256-byte memory map in EEPROM that is accessible over a 2-wire serial interface at the 8 bit address 1010000X (A0h). The digital diagnostic monitoring interface makes use of the 8 bit address 1010001X (A2h), so the originally defined serial ID memory map remains unchanged. The interface is identical to, and is thus fully backward compatible with both the GBIC Specification and the SFP+ Multi Source Agreement.

The operating and diagnostics information is monitored and reported by a Digital Diagnostics Transceiver Controller (DDTC) inside the transceiver, which is accessed through a 2-wire serial interface. When the serial protocol is activated, the serial clock signal (SCL, Mod Def 1) is generated by the host. The positive edge clocks data into the SFP transceiver into those segments of the E2PROM that are not write-protected. The negative edge clocks data from the SFP transceiver. The serial data signal (SDA, Mod Def 2) is bi-directional for serial data transfer. The host uses SDA in conjunction with SCL to mark the start and end of serial protocol activation. The memories are organized as a series of 8-bit data words that can be addressed individually or sequentially. Digital diagnostics for the ESP5561-3LCD40 are internally calibrated by default.

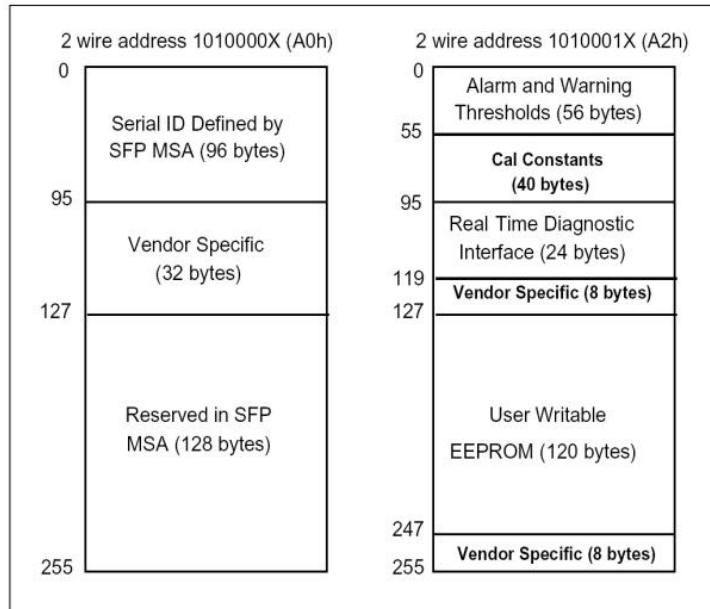

Mechanical Specifications

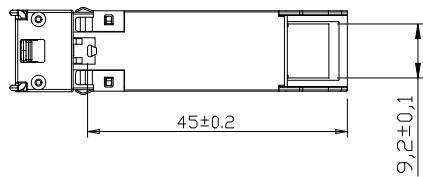
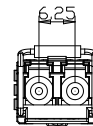
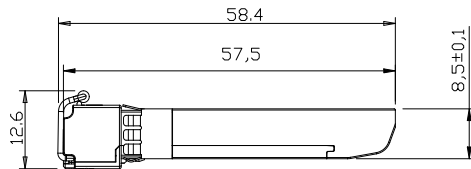
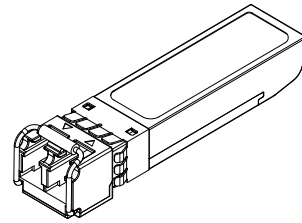
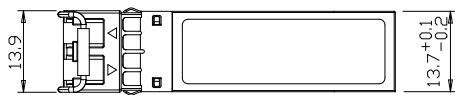

Units in mm

Regulatory Compliance

Feature	Reference	Performance
Electrostatic discharge (ESD)	IEC/EN 61000-4-2	Compatible with standards
Electromagnetic Interference (EMI)	FCC Part 15 Class B EN 55022 Class B (CISPR 22A)	Compatible with standards
Laser Eye Safety	FDA 21CFR 1040.10, 1040.11 IEC/EN 60825-1, 2	Class 1 laser product
Component Recognition	IEC/EN 60950, UL	Compatible with standards
ROHS	2002/95/EC	Compatible with standards
EMC	EN61000-3	Compatible with standards

8

Compatibility Test

In order to ensure the product compatibility, our products will be tested on the switch before shipment. Our modules can compatible with many mainstream brand switches, such as Cisco, Juniper, Extreme, Brocade, IBM, H3C, HP, Huawei, D-Link, Mikrotik, ZTE, TP-Link...

Our test equipment: VOLKTEK MEN-4110, HP 2530-8G, CRS226-24G-25+RM, Catalyst 2960G Series, Catalyst 3850 XS 10G SFP+, Catalyst 3750-E Series, HUAWEI S5700Series, H3C S3100V2 Series, Juniper-EX4200, etc.



Cisco Catalyst 3850



HUAWEI S5700



H3C S3100V2



HP J9264AR



Juniper EX 4200



Alcatel 6850E-U24X



Mikrotik CR5226-24G-25+RM



Cisco Catalyst 2960G



Volktek MEN-4110

Product Production Process

Quality Assurance

Continuous introduction of new equipment, produced by strict standards, strict quality inspection, to guarantee the high quality standard of each product.



**Standardized
Production Line**



**Professional
Welding**



Assembling



Aging Testing

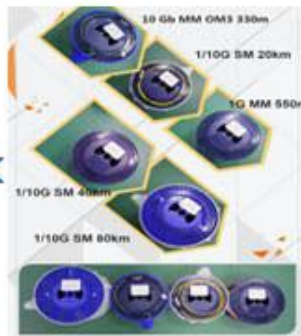

Distance Testing



Cleaning end face



Product Initial Test



Switch Testing



Product Final Test

Packaging

ETU-Link provides two kinds of packaging, 10pcs/Tray and individual package.



Company: ETU-Link Technology Co., LTD

Address: 4th Floor, C Building, JinBoLong Industrial Park, QingQuan Road, LongHua District, Shenzhen city, GuangDong

Tel: +86-755 2328 4603

Addresses and phone number also have been listed at www.etulinktechnology.com.

Please e-mail us at sales@etulinktechnology.com or call us for assistance.