

EB23(32)X-1D(I)

10Gb/s SFP+ BIDI 1km DDM Transceiver

PRODUCT FEATURES

- Support data rate up to 11.3Gb/s
- Hot-Pluggable SFP Footprint and Single LC Connector
- Up to 1km reach for G.652 SMF
- 1270nm DFB Transmitter and 1330 PIN receiver for EB23X-1D(I)
- 1330nm DFB Transmitter and 1270 PIN receiver for EB32X-1D(I)
- Temperature Range:
 - Commercial: 0°C ~70°C
 - Industrial: -40°C ~85°C
- Power consumption <1W
- Compliant with SFP-8431
- Compliant with SFP-8432
- Compliant with SFP-8472
- Compliant with IEEE802.3ae
- RoHS 6 compliance
- Complies with EU Directive 2015/863/EU



APPLICATIONS

- 10GBASE-LR at 10.3125Gbps
- 10GBASE-LW at 9.953Gbps
- Other Optical Links

DESCRIPTIONS

The EB23(32)X-1D(I) series single mode transceiver is small form factor pluggable module for duplex optical data communications such as 10GBASE-LR/LW defined by IEEE 802.3ae. It is with the SFP+ 20-pin connector to allow hot plug capability.

The EB23(32)X-1D(I) module is designed for single mode fiber and operates at a nominal wavelength of 1270nm or 1330nm; the transmitter section uses a multiple quantum well DFB, which is class 1 laser compliant according to International Safety Standard IEC-60825.

The receiver section uses an integrated InGaAs detector preamplifier (IDP) mounted in an optical header and a limiting post-amplifier IC.

Module Block Diagram

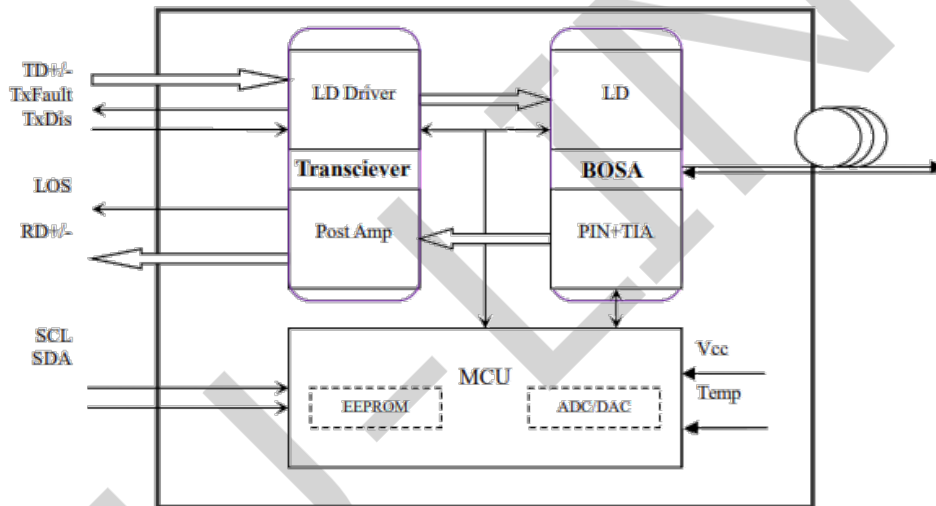

Ordering Information

Part No.	Data Rate(optical)	Laser	Fiber Type	Distance	Optical Interface	Temp	DDMI	Latch Color
EB23X-1D	10.3125Gbps	DFB	SMF	1km	LC	0~70°C	Y	Gray
EB32X-1D	10.3125Gbps	DFB	SMF	1km	LC	0~70°C	Y	Green
EB23X-1DI	10.3125Gbps	DFB	SMF	1km	LC	-40~85°C	Y	Gray
EB32X-1DI	10.3125Gbps	DFB	SMF	1km	LC	-40~85°C	Y	Green

Absolute Maximum Ratings

Parameter	Symbol	Min.	Typical	Max.	Unit	Notes
Storage Temperature	T _{stg}	-40		+85	°C	
Case Operating Temperature(Commercial)	T _o	0		70	°C	
Case Operating Temperature (Industrial)	T _o	-40		85	°C	
Relative Humidity - Storage	R _{HS}	5		95	%	
Relative Humidity - Operating	R _{HO}	5		85	%	

DC Supply Voltage	V _{CC}	0		3.6	V	
-------------------	-----------------	---	--	-----	---	--

Recommended Operating Conditions

Parameter	Symbol	Min.	Typical	Max.	Unit	Notes
Case Operating Temperature	T _{op}	0	-	70	°C	Commercial
		-40		85		Industrial
Power Supply Voltage	V _{CC}	3.13	3.3	3.47	V	
Supply Current	I _{CC}			300	mA	
Data Rate			10.3125		Gb/s	
Transmission Distance	TD	-	-	1	km	Over SMF

Electrical Characteristics

High-Speed Signal: Compliant to CEI-11G-SR

Low-Speed Signal: Compliant to SFF-8431

Parameter	Symbol	Min.	Typical	Max.	Unit	Notes
Supply Voltage	V _{CC}	3.135		3.465	V	
Supply Current	I _{CC}			300	mA	
Power Consumption	P			1.0	W	
Transmitter (Module Input)						
Differential Input Resistance	R _{Rdin}	80	100	120	Ω	
Input Differential Voltage	R _{Vdiff}	110	-	1050	mVpp	
Tx_Disable	Normal Operation	V _{IL}	-0.3	-	0.8	V
	Laser Disable	V _{IH}	2.0	-	V _{CC} +0.3	V
Receiver (Module Output)						
Differential Resistance	T _{Rd}	80	100	120	Ohm	
Output Differential Voltage	T _{Vdiff}	360	-	770	mVpp	
Differential Termination Resistance Mismatch	T _{Rdm}	-	-	5	%	
Rx los	Normal Operation	V _{OL}	-0.3	-	0.4	V
	Loss Signal	V _{OH}	2		V _{CC} HOST	V

Optical and Characteristics

Parameter	Symbol	Min.	Typical	Max.	Unit	Notes
Transmitter						
Average Output Power	POUT	-6		-1	dBm	1
Average Output Power(Laser Off)	POFF			-30	dBm	
Wavelength	λ	1260		1280	nm	EB23X-10D(I)
		1320		1340		EB32X-10D(I)
Spectrum Bandwidth @ -20dB	Δλ			1	nm	

Optical Communications Products Alliance

Side mode suppression ratio(SMSR)	SMSR	30			dB	
Extinction ratio	ER	3.5			dB	
RIN _{20OMA}	RIN			-128	dB/Hz	
Optical return loss tolerance	ORLT	20			dB	
Receiver						
Wavelength	λ	1320		1340	nm	EB23X-10D(I)
		1260		1280		EB32X-10D(I)
Received Sensitivity	P _{IN}			-14.4	dBm	BER<1x10 ⁻¹²
Optical Power Overload	P _{IN} (SAT)	0.5			dBm	
Damage threshold			1.5		dBm	2
Receiver Reflectance	RFL			-12	dB	
Rx_LOS of Signal Assert	P _A	-30			dBm	
Rx_LOS of Signal De-assert	P _D			-18	dBm	
Rx_LOS of Signal Hysteresis	PHy	0.5		5	dB	
Optical Return Loss Tolerance	ORLT	20			dB	

Notes:

1. The optical power is launched into SMF.
2. The receiver shall be able to tolerate, without damage, continuous exposure to an optical input signal having this average power level. The receiver does not have to operate correctly at this input power.

Digital Diagnostics

Parameter	Range	Accuracy	Unit	Calibration
Temperature	-40 to 85	±3	°C	Internal
Voltage	0 to V _{cc}	±3%	V	Internal
Tx Bias Current	0 to 100	±10%	mA	Internal
Tx Output Power	-6 to 0	±3	dB	Internal
Rx Input Power	-15 to 0.5	±3	dB	Internal

Communication Interface Timing Characteristics

Parameter	Symbol	Min.	Typical	Max.	Unit	Notes
TX_Disable Assert Time	t _{off}			100	us	
TX_Disable Negate Time	t _{on}			2	ms	
Time to Initialize Include Reset of TX_FAULT	t _{int}			300	ms	
TX_FAULT from Fault to Assertion	t _{fault}			100	us	
TX_Disable Time to Start Reset	t _{reset}	10			us	
Receiver Loss of Signal Assert Time	T _{A,RX_LOS}			100	us	
Receiver Loss of Signal Deassert Time	T _{D,RX_LOS}			100	us	

Rate-Select Chage Time	t_ratesel			10	us	
------------------------	-----------	--	--	----	----	--

Pin Diagram

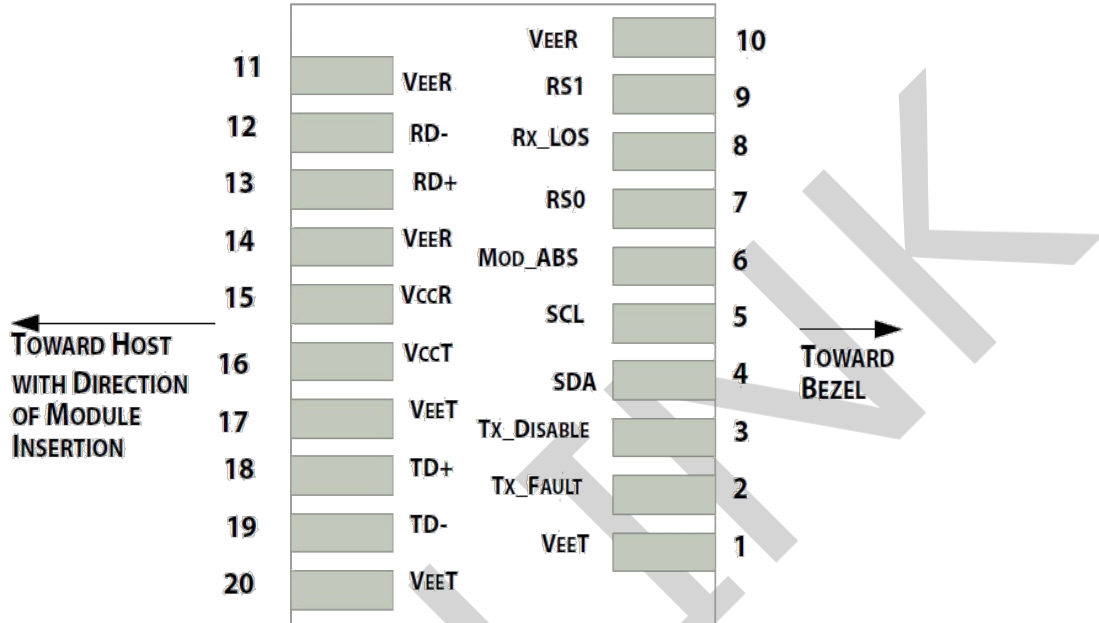

Pin Definitions

Pin	Symbol	Name/Description	Ref.
1	V_{EET}	Transmitter Ground (Common with Receiver Ground)	1
2	T_{FAULT}	Transmitter Fault.	2
3	T_{DIS}	Transmitter Disable. Laser output disabled on high or open.	3
4	SDA	2-wire Serial Interface Data Line	4
5	SCL	2-wire Serial Interface Clock Line	4
6	MOD_ABS	Module Absent. Grounded within the module	4
7	RS0	Rate Select 0	5
8	LOS	Loss of Signal indication. Logic 0 indicates normal operation.	6
9	RS1	No connection required	1
10	V_{EER}	Receiver Ground (Common with Transmitter Ground)	1
11	V_{EER}	Receiver Ground (Common with Transmitter Ground)	1
12	RD-	Receiver Inverted DATA out. AC Coupled	
13	RD+	Receiver Non-inverted DATA out. AC Coupled	
14	V_{EER}	Receiver Ground (Common with Transmitter Ground)	1
15	V_{CCR}	Receiver Power Supply	
16	V_{CCT}	Transmitter Power Supply	
17	V_{EET}	Transmitter Ground (Common with Receiver Ground)	1
18	TD+	Transmitter Non-Inverted DATA in. AC Coupled.	
19	TD-	Transmitter Inverted DATA in. AC Coupled.	

20	V _{EET}	Transmitter Ground (Common with Receiver Ground)	1
----	------------------	--	---

Notes:

- 1) Circuit ground is internally isolated from chassis ground.
- 2) T_{FAULT} is an open collector/drain output, which should be pulled up with a 4.7k – 10k Ohms resistor on the host board if intended for use. Pull up voltage should be between 2.0V to V_{cc} + 0.3V. A high output indicates a transmitter fault caused by either the TX bias current or the TX output power exceeding the preset alarm thresholds. A low output indicates normal operation. In the low state, the output is pulled to <0.8V.
- 3) Laser output disabled on T_{DIS} >2.0V or open, enabled on T_{DIS} <0.8V.
- 4) Should be pulled up with 4.7kΩ- 10kΩ host board to a voltage between 2.0V and 3.6V. MOD_ABS pulls line low to indicate module is plugged in.
- 5) Internally pulled down per SFF-8431 Rev 4.1.
- 6) LOS is open collector output. It should be pulled up with 4.7kΩ – 10kΩ on host board to a voltage between 2.0V and 3.6V. Logic 0 indicates normal operation; logic 1 indicates loss of signal.

Recommended Interface Circuit

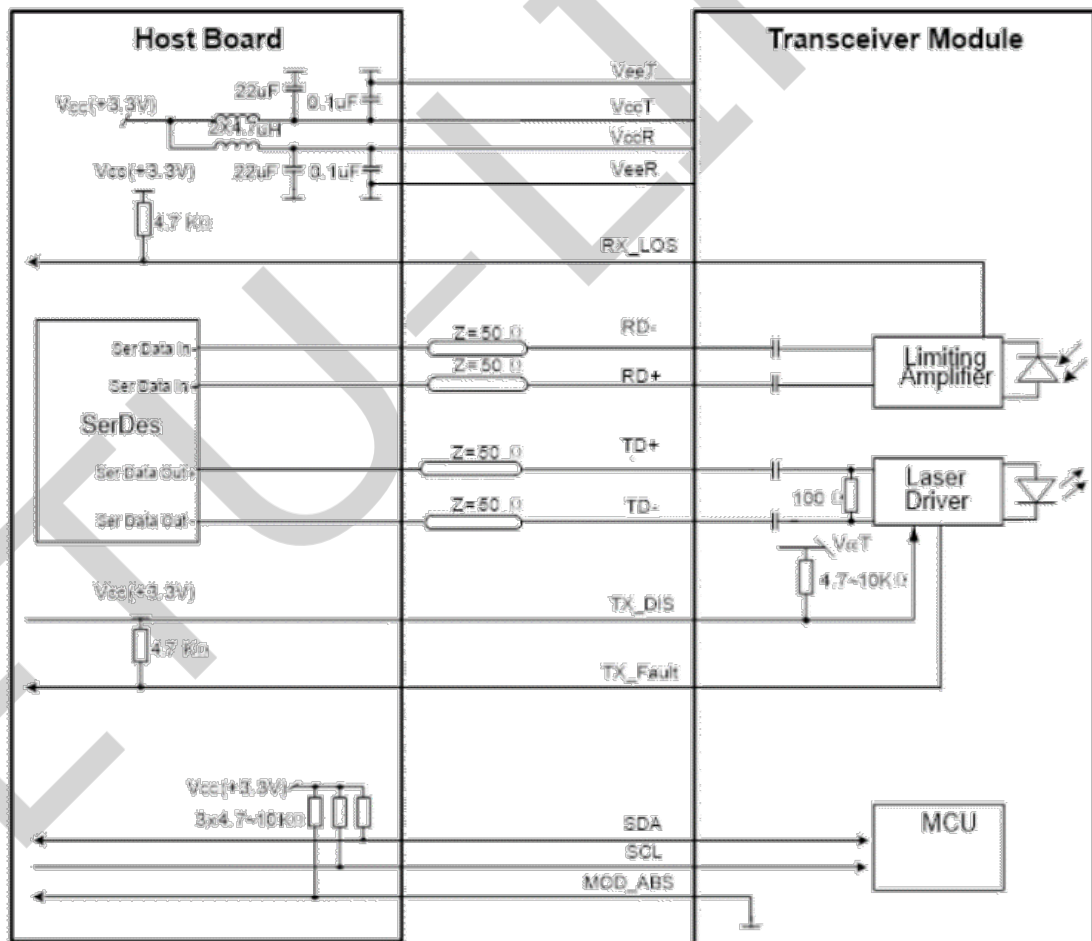

Mechanical Diagram

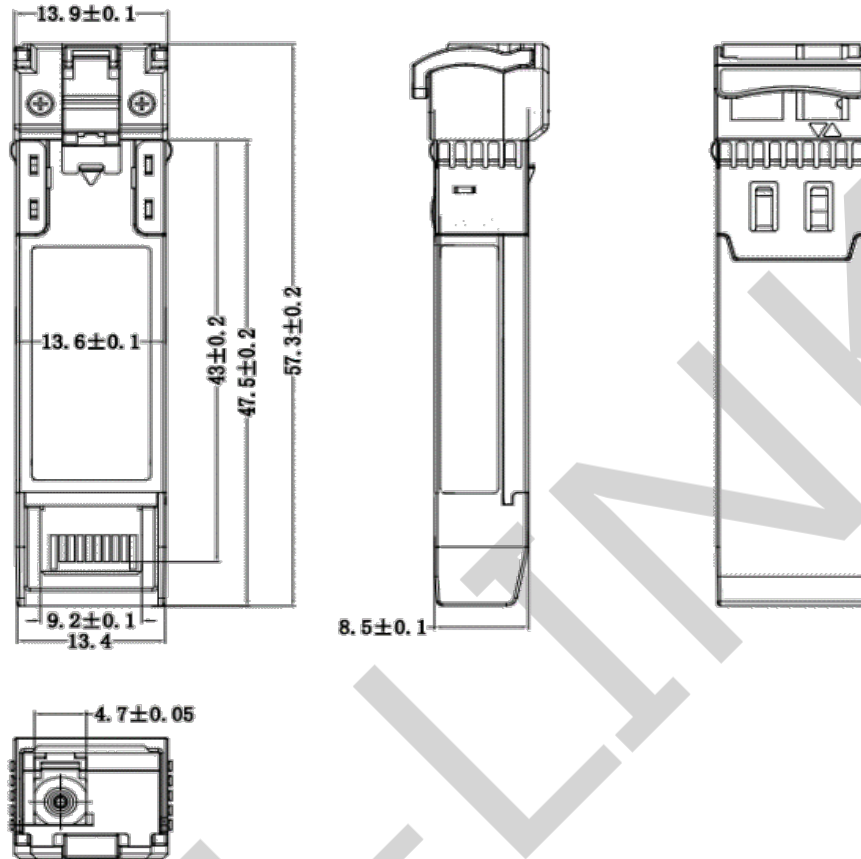

Revision History

Version No.	Date	Description
1.0	Oct 18, 2015	Preliminary datasheet
2.0	September 13, 2019	Product upgrades
3.0	Aug 26, 2024	Format change

Company: ETU-Link Technology Co., LTD

Production base: Right side of 3rd floor, No. 102 building, Longguan expressway, Dalang street, Longhua District, Shenzhen city, Guangdong Province, China 518109

R&D base: Floor 4, Building 4, Nanshan Yungu Phase LI, Taoyuan Community, Xili Street, Nanshan District, Shenzhen

Tel: +86-755 2328 4603

Addresses and phone number also have been listed at www.etulinktechnology.com.

Please e-mail us at sales@etulinktechnology.com or call us for assistance.