

SFP

ESCxx24-3LCD120

2.67Gbps CWDM SFP Optical Transceiver, 120KM Reach

- Data-rate of 2.67Gbps operation
- 8 CWDM DFB wavelengths laser and APD photodetector for 120KM transmission
- Compliant with SFP MSA and SFF-8472 with duplex LC receptacle
- Digital Diagnostic Monitoring:
Internal Calibration or External Calibration
- Compatible with RoHS
- +3.3V single power supply
- Operating case temperature: Standard : 0 to +70°C



Applications

- Switch to Switch Interface
- Gigabit Ethernet
- Switched Backplane Applications
- Router/Server Interface
- Other Optical Links

Description

ETU-Link's ESCXX24-3LCD120 Small Form Factor Pluggable (SFP) transceivers are compatible with the Small Form Factor Pluggable Multi-Sourcing Agreement (MSA). The transceiver consists of five sections: the LD driver, the limiting amplifier, the digital diagnostic monitor, the 1XX0nm DFB laser and the APD .The module data linkup to 120KM in 9/125um single mode fiber.

The optical output can be disabled by a TTL logic high-level input of Tx Disable, and the system also can disable the module via I2C. Tx Fault is provided to indicate that degradation of the laser. Loss of signal (LOS) output is provided to indicate the loss of an input optical signal of receiver or the link status with partner. The system canals

get the LOS (or Link)/Disable/Fault information via I2C register access.

Module Block Diagram

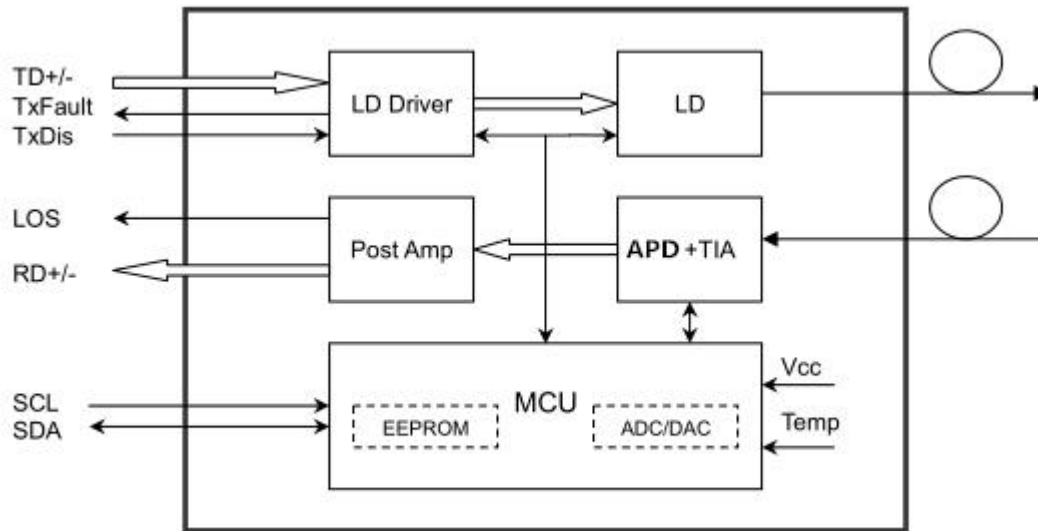

Product Selection

ESCXX24-3LCD120

Wavelength	xx	Clasp Color Code	Wavelength	xx	Clasp Color Code
1470 nm	47	Gray	1550 nm	55	Yellow
1490 nm	49	Purple	1570 nm	57	Orange
1510 nm	51	Blue	1590 nm	59	Red
1530 nm	53	Green	1610 nm	61	Brown

Recommended Operating Conditions

Parameter	Symbol	Min.	Typ.	Max.	Unit	Note
Case Operating Temperature	Tcase	0		70	°C	
Power Supply Voltage	VCC	3.13	3.3	3.47	V	
Power Supply Current	ICC			300	mA	
Power Supply Noise Rejection				100	mVp-p	100Hz to 1MHz
Data Rate			2670		Mbps	TX Rate/RX Rate
Transmission Distance				120	KM	
Coupled Fiber	Single mode fiber					9/125um SMF

Specification of Transmitter

Parameter	Symbol	Min.	Typ.	Max.	Unit	Note
Case Operating Temperature	Tcase	0		70	°C	
Power Supply Voltage	VCC	3.13	3.3	3.47	V	
Power Supply Current	ICC			300	mA	
Power Supply Noise Rejection				100	mVp-p	100Hz to 1MHz
Data Rate			2670		Mbps	TX Rate/RX Rate
Transmission Distance				120	KM	
Coupled Fiber	Single mode fiber					9/125um SMF

1)

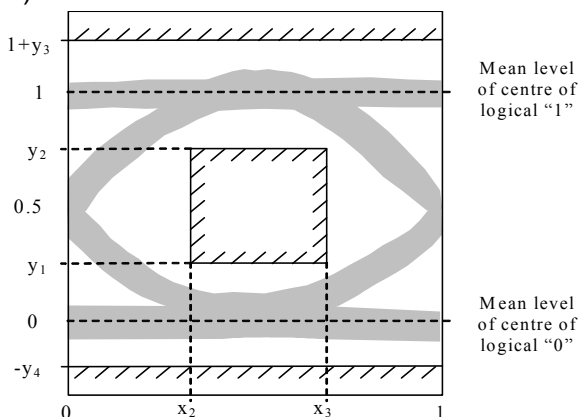

$x_3 - x_2$	0.2
y_1	0.25
y_2	0.75
y_3	0.25
y_4	0.25

Specification of Receiver

Parameter	Symbol	Min.	Typ.	Max.	Unit	Note
Average Output Power	POUT	0		5	dBm	Note (1)
Extinction Ratio	ER	9			dB	
Center Wavelength	λ_C	$(1XX0)-\Delta\lambda$	1XX0	$(1XX0)+\Delta\lambda$	nm	DFB Laser Note (2)
Side Mode Suppression Ratio	SMSR	30			dB	
Spectrum Bandwidth(-20dB)	σ			1	nm	
Transmitter OFF Output Power	POff			-45	dBm	
Differential Line Input Impedance	RIN	90	100	110	Ohm	
Output Eye Mask	Compliant with G.957 (class 1 laser safety)					Note (3)

Parameter	Symbol	Min.	Typ.	Max.	Unit	Note
Input Optical Wavelength	λ_{IN}	1270		1610	nm	APD
Receiver Sensitivity	PIN			-29	dBm	Note (1)
Input Saturation Power (Overload)	PSAT	-9			dBm	
Los Of Signal Assert	PA	-45			dBm	
Los Of Signal De-assert	PD			-31	dBm	Note (2)
LOS Hysteresis	PA-PD	0.5	2	6	dB	

Notes:

- 1) The optical power is launched into SMF.
- 2) PECL input, internally AC-coupled and terminated.
- 3) Measured with a PRBS 223-1 test pattern @2488Mbps, BER $\leq 1 \times 10^{-12}$
- 4) AC-coupled internally.

Electrical Interface Characteristics

Parameter	Symbol	Min.	Typ.	Max.	Unit	Note
Transmitter						
Total Supply Current	ICC			A	mA	Note (1)
Transmitter Disable Input-High	VDISH	2		Vcc+0.3	V	
Transmitter Disable Input-Low	VDISL	0		0.8	V	
Transmitter Fault Input-High	VTxFH	2		Vcc+0.3	V	

Transmitter Fault Input-Low	VTxFL	0		0.8	V	
Receiver						
Total Supply Current	ICC			B	mA	Note (1)
LOSS Output Voltage-High	VLOSH	2		V _{cc} +0.3	V	LVTTTL
LOSS Output Voltage-Low	VLOSL	0		0.8	V	

Note

- 1) $A (TX) + B (RX) = 300\text{mA}$ (Not include termination circuit)

Pin Definitions

Pin	Symbol	Name/Description	NOTE
1	V _{EET}	Transmitter Ground (Common with Receiver Ground)	1
2	T _{FAULT}	Transmitter Fault.	
3	T _{DIS}	Transmitter Disable. Laser output disabled on high or open.	2
4	MOD_DEF(2)	Module Definition 2. Data line for Serial ID.	3
5	MOD_DEF(1)	Module Definition 1. Clock line for Serial ID.	3
6	MOD_DEF(0)	Module Definition 0. Grounded within the module.	3
7	Rate Select	No connection required	4
8	LOS	Loss of Signal indication. Logic 0 indicates normal operation.	5
9	V _{EER}	Receiver Ground (Common with Transmitter Ground)	1
10	V _{EER}	Receiver Ground (Common with Transmitter Ground)	1
11	V _{EER}	Receiver Ground (Common with Transmitter Ground)	1
12	RD-	Receiver Inverted DATA out. AC Coupled	
13	RD+	Receiver Non-inverted DATA out. AC Coupled	
14	V _{EER}	Receiver Ground (Common with Transmitter Ground)	1
15	V _{CCR}	Receiver Power Supply	
16	V _{CCT}	Transmitter Power Supply	
17	V _{EET}	Transmitter Ground (Common with Receiver Ground)	1

18	TD+	Transmitter Non-Inverted DATA in. AC Coupled.	
19	TD-	Transmitter Inverted DATA in. AC Coupled.	
20	V _{EET}	Transmitter Ground (Common with Receiver Ground)	1

Notes:

- 1) Circuit ground is internally isolated from chassis ground.
- 2) Laser output disabled on T_{DIS}>2.0V or open, enabled on T_{DIS}<0.8V.
- 3) Should be pulled up with 4.7k - 10kohms on host board to a voltage between 2.0V and 3.6V. MOD_DEF (0) pulls line low to indicate module is plugged in.
- 4) This is an optional input used to control the receiver bandwidth for compatibility with multiple data rates (most likely Fiber Channel 1x and 2x Rates). If implemented, the input will be internally pulled down with > 30kΩ resistor. The input states are:
 - a) Low (0 – 0.8V): Reduced Bandwidth
 - b) (>0.8, < 2.0V): Undefined
 - c) High (2.0 – 3.465V): Full Bandwidth
 - d) Open: Reduced Bandwidth
- 5) LOS is open collector output should be pulled up with 4.7k - 10kohms on host board to a voltage between 2.0V and 3.6V. Logic 0 indicates normal operation; logic 1 indicates loss of signal.

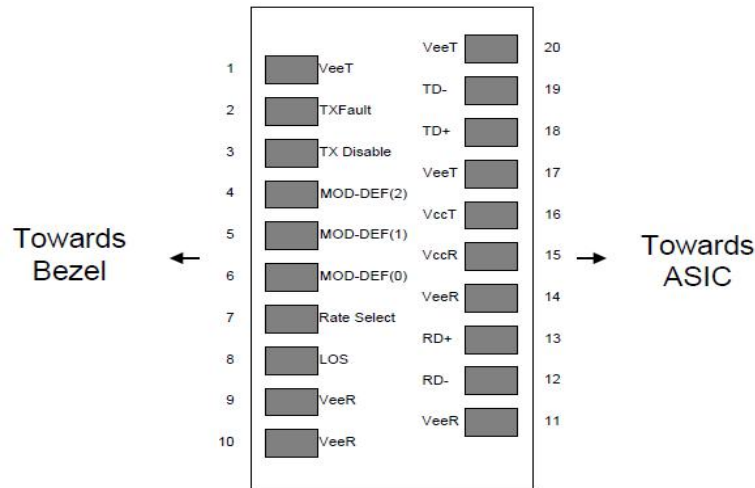

Figure2. Pin out of Connector Block on Host Board

Absolute Maximum Ratings

Parameter	Symbol	Min.	Typ.	Max.	Unit	Note
Storage Temperature	T _s	-40		85	°C	
Relative Humidity	RH	5		95	%	
Power Supply Voltage	V _{CC}	-0.5		4	V	
Signal Input Voltage		-0.3		V _{CC} +0.3	V	
Receiver Damage Threshold		+6			dBm	

Digital Diagnostic Functions

ETU-LINK ESCXX24-3LCD120 transceivers support the 2-wire serial communication protocol as defined in the SFP MSA. It is very closely related to the E2PROM defined in the GBIC standard, with the same electrical specifications.

The standard SFP serial ID provides access to identification information that describes the transceiver's capabilities, standard interfaces, manufacturer, and other information.

Additionally, ETU-LINK SFP transceivers provide a unique enhanced digital diagnostic monitoring interface, which allows real-time access to device operating parameters such as transceiver temperature, laser bias current transmitted optical power, and received optical power and transceiver supply voltage. It also defines a sophisticated system of alarm and warning flags, which alerts end-users when particular operating parameters are outside of a factory set normal range.

The SFP MSA defines a 256-byte memory map in E2PROM that is accessible over a 2-wire serial interface at the 8 bit address 1010000X (A0h). The digital diagnostic monitoring interface makes use of the 8 bit address 1010001X (A2h), so the originally defined serial ID memory map remains unchanged. The interface is identical to, and is thus fully backward compatible with both the GBIC Specification and the SFP Multi Source Agreement.

The operating and diagnostics information is monitored and reported by a Digital Diagnostics Transceiver Controller (DDTC) inside the transceiver, which is accessed through a 2-wire serial interface. When the serial protocol is activated, the serial clock signal (SCL, Mod Def 1) is generated by the host. The positive edge clocks data into the SFP transceiver into those segments of the E2PROM that are not write-protected. The negative edge clocks data from the SFP transceiver. The serial data signal (SDA, Mod Def 2) is bi-directional for serial data transfer. The host uses SDA in conjunction with SCL to mark the start and end of serial protocol activation. The memories are organized as a series of 8-bit data words that can be addressed individually or sequentially.

Digital diagnostics for the ESCXX24-3LCD120 are internally calibrated by default

Mechanical Specifications

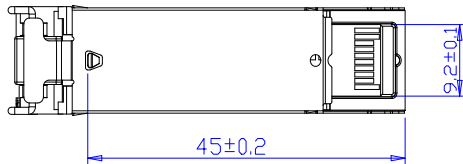

Units in mm

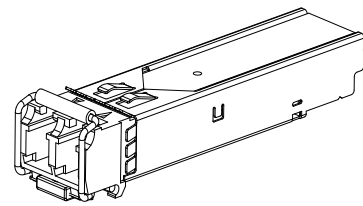
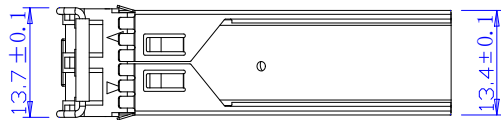
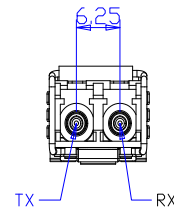
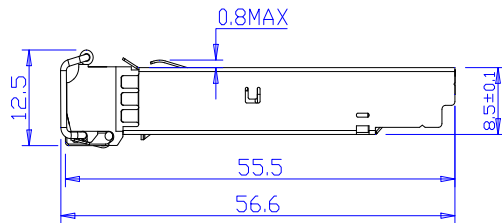

Regulatory Compliance

Feature	Reference	Performance
Electrostatic discharge (ESD)	IEC/EN 61000-4-2	Compatible with standards
Electromagnetic Interference (EMI)	FCC Part 15 Class B EN 55022 Class B (CISPR 22A)	Compatible with standards
Laser Eye Safety	FDA 21CFR 1040.10, 1040.11 IEC/EN 60825-1, 2	Class 1 laser product
Component Recognition	IEC/EN 60950, UL	Compatible with standards
ROHS	2002/95/EC	Compatible with standards
EMC	EN61000-3	Compatible with standards

Compatibility Test

In order to ensure the product compatibility, our products will be tested on the switch before shipment. Our modules can compatible with many mainstream brand switches, such as Cisco, Juniper, Extreme, Brocade, IBM, H3C, HP, Huawei, D-Link, Mikrotik, ZTE, TP-Link...

Our test equipment: VOLKTEK MEN-4110, HP 2530-8G, CRS226-24G-25+RM, Catalyst 2960G Series, Catalyst 3850 XS 10G SFP+, Catalyst 3750-E Series, HUAWEI S5700Series, H3C S3100V2 Series, Juniper-EX4200, etc.



Cisco Catalyst 3850



HUAWEI S5700



H3C S3100V2



HP J9264AR



Juniper EX 4200



Alcatel 6850E-U24X



Mikrotik CR5226-24G-25+RM



Cisco Catalyst 2960G



Volktek MEN-4110

Product Production Process

Quality Assurance

Continuous introduction of new equipment, produced by strict standards, strict quality inspection, to guarantee the high quality standard of each product.



**Standardized
Production Line**



**Professional
Welding**



Assembling



Aging Testing

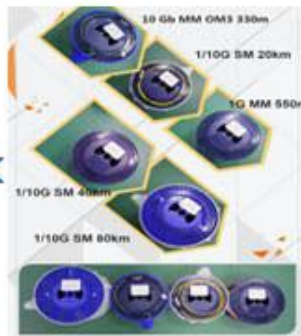

Distance Testing



Cleaning end face



Product Initial Test



Switch Testing



Product Final Test

Packaging

ETU-Link provides two kinds of packaging, 10pcs/Tray and individual package.



Company: ETU-Link Technology Co., LTD

Address: 4th Floor, C Building, JinBoLong Industrial Park, QingQuan Road, LongHua District, Shenzhen city, Guangdong Province, China 518109

Tel: +86-755 2328 4603

Addresses and phone number also have been listed at www.etulinktechnology.com.

Please e-mail us at sales@etulinktechnology.com or call us for assistance.